

Pro'sKit®

SS-331 LCD Desoldering Station



User's Manual

1st Edition,

©2021 Copyright by Prokit's Industries Co., Ltd.

Description

SS-331 designed for lead free desoldering especially. The quick heating and strong power are for convenient and clear soldering / desoldering all types of DIP components.

Reasonable structure, single hand operation and strong absorbing power can be easy removal of the residual solder from the one-sided or two sided of the PCB.

This tool is used in the fields of electronic research, teaching and production, especially in the repairing and desoldering on the electronic appliances and communication equipments.

1. Control Unit



The desoldering iron gun is controlled automatically by the micro-processor. The digital control electronics and high-quality sensor and heat exchange system guarantee precise temperature control at the soldering tip. The highest degree of temperature precision and optimal dynamic thermal behavior under load conditions is obtained by the quick and accurate recording of the measured values in a closed control circuit, and this design is especially for the lead-free production techniques.

2. Desoldering Iron gun (5SS-331N1-DG)

Desoldering iron gun with a power of 90W and a wide spectrum of soldering tips can be used anywhere in the electronics field.

The high power and gun type design make this iron gun suitable for fine desoldering work. The heating element is made of ceramic and the sensor on the desoldering tip can control the desoldering temperature quickly and accurately.

Technical Specification

Model No.	SS-331B	SS-331H	SS-331E
Voltage	220V-240V~ 50Hz		120V~ 60Hz
Soldering Power	90W		
Power Consumption	140W		
Temperature	160°C ~ 480°C		
Vacuum Pressure	>600mm Hg		
Heating Element	Ceramic Heater		
Sleep mode	Approximately 10 minutes if not use		
Accessories	Spare tip x 3 (∅ 1.2(on the gun)∅1.0/ ∅ 1.5mm) Cleaning tool x 3 (∅0.7/∅0.9/∅ 1.2mm) Filter sponge x 4 (φ20.8x1 +φ16.8x3)		
Certificate	CE, RoHS	RoHS	cTUVus, RoHS
Plug			
Station Size (mm)	172 x 135 x 190		
Weight (kgs)	1.6		

Operating Instruction

1. Place the desoldering iron gun in the holder separately. Then connect the plug to the receptacle on the station and turn clockwise to tighten the plug nut. Check that the power supply is corresponding to the specification on the type plate and the power switch is on the "OFF" position. Connect the control unit to the power supply and switch on the power. Then a self-test is carried out in which all display elements are switched on briefly. The electronic system then switches on automatically to the set temperature and displays this value.
2. If not use for about 10 minutes ,the desolering station will be automatically into sleeping mode and the temperature is reduced to 200 C, this for prolonged the life of the suction nozzle and the heating element; Shake or pick up the desoldering Iron gun, can start the working again.
3. The display and temperature setting

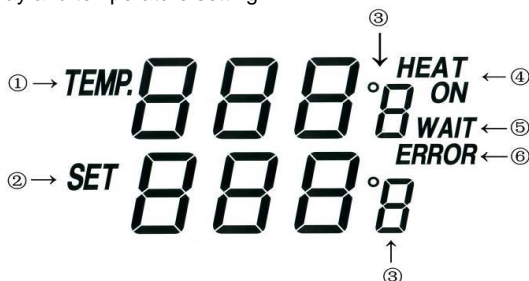

- ①. Shows the actual temperature of the desoldering tip.
- ②. Shows the setting temperature: Pressing the "UP" or "DOWN" button can switch the digital display to the set point display. The set-point can be changed for $\pm 1^{\circ}\text{C}$ by tapping the "UP" or "DOWN" button. Pressing the button will change the set-point quickly. The digital display will return automatically to the actual value and the iron will reach to the setting temperature quickly.
- ③. $^{\circ}\text{C}/^{\circ}\text{F}$ display: Switching the temperature display from $^{\circ}\text{C}$ to $^{\circ}\text{F}$ by pressing the "*" button and then the electronic system will display the actual temperature① and setting temperature② in $^{\circ}\text{F}$, and vice versa.
- ④. When the actual temperature on the desoldering tip is less than the set-point, "HEAT ON" will display and make the desoldering tip heating up.
- ⑤. When the absolute offset is more than $\pm 10^{\circ}\text{C}$ between the actual temperature and the set-point on the desoldering tip or the nozzle, "WAIT" will display. It means that the temperature electronic control system is not in the stable situation, we should wait a moment to let the "WAIT" disappear.
- ⑥. When "----" & "ERROR" display, there may be a trouble on the system, or the desoldering iron gun is not connected to the control system correctly.

Safety Instruction

1. The manufacturer assumes no liability for uses other than those described in the operating instructions or for unauthorized alterations.
2. The operating instructions and cautions should be read carefully and kept in an easily visible location in the vicinity of the control system. Non-observance of the cautions will result in accidents, injury or risks to health.

Caution

1. The power cord only can be inserted in approved power sockets or adapters.
2. High Temperature

When the temperature of the desoldering tip will reach as high as around 400°C (752 °F) When the power switch is on. Since mishandling may lead to burns and fire, be sure to comply with the following precautions:

 - A. Do not touch metallic parts near the desoldering tip/ nozzle.
 - B. Do not use this system near the flammable items.
 - C. Advise other people in the work area that the unit can reach a very high temperature and should be considered potentially dangerous.
 - D. Turn off the power switch while taking breaks and when finishing using.
 - E. Before replacing parts or storing the system, turn off the power and let it cool down to the room temperature.
 - F. Warning: this tool must be placed on its stand when not in use.
 - G. A fire may result if the appliance is not used with care, therefore:
 - a) Be careful when using the appliance in places where there is combustible material.
 - b) Do not apply to the same place for a long time.
 - c) Do not use in presence of an explosive atmosphere.
 - d) Be aware heat may be conducted to combustible materials that out of sight.
 - e) Place the appliance on its stand after use and allow it to cool down before storage.
 - f) Do not leave the appliance unattended when it is switched on.
3. Take care of your tools

Do not use the tools for any applications other than desoldering.
Do not rap the iron against the work bench or otherwise subject the iron to severe shocks.
Do not file the desoldering tip to remove the oxide, please wipe the tip on the cleaning sponge.
Use only accessories or attachments which are listed in the operation manual.
Use of other tools and other accessories can lead to a danger of injury.
Please turn off the power before connecting or disconnecting the desoldering iron gun.
4. Maintenance
 - 4.1 Before further use, safety devices or slightly damaged parts must be carefully checked for error-free and intended operation.
 - 4.2 Inspect moving parts for error-free operation and that they don't bind, or whether any parts are damaged.
 - 4.3 Damaged safety devices and parts must be repaired or replaced by a qualified technician, so long as nothing else is indicated in the operation manual.
 - 4.4 Use only accessories or attachments which are listed in the operation manual. Use of other tools and other accessories can lead to a danger of injury.

5. Keep children at a distance

Warning: this appliance is not intended for use by young children and infirm persons unless they have been adequately supervised by a responsible person to ensure that they can use the appliance safely.

Warning: Young children should be supervised to ensure that they do not play with the appliance.

Unused desoldering station should be stored in a dry location which is out of the reach of children. Switch off all unused desoldering station.

6. Protect yourself against electrical shocks

Avoid touching grounded parts with your body, e.g. pipes, heating radiators and so on. The grip of antistatic designed desoldering tool is conductive.

7. Work environment

Do not use the desoldering station in a moist or wet environment. The desoldering iron gun should be placed on the holder after finished using.

8. Observe the valid safety regulations at your work place.

Desoldering Gun Maintenance

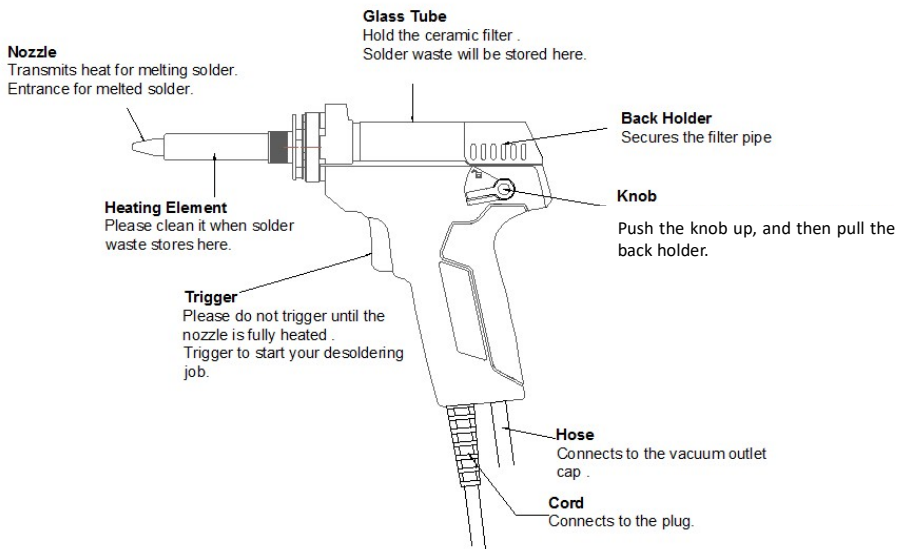

WARNINGS:

1. To avoid injury or damage the items, do not touch the metallic parts near the nozzle, and do not use this system near the flammable items.
2. Remove the power plug before performing maintenance procedure, except doing the nozzle and heating element clean process.
3. If the pump does not operate, immediately clean the nozzle & heating element, and replace the filter

- In the high temperature, the solder waste will get oxidized(lead free solder's melting point is 220° C, non-lead free solder's melting point is 180° C),swelled and stuck on the inner wall tightly, If it did not clean after use, the solder waste will block the desoldering gun, can not remove even use cleaning pin.

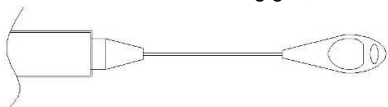

(Cleaning pin)

Please follow below steps to remove the solder waste:

- Push the knob up, and then pull the back holder.

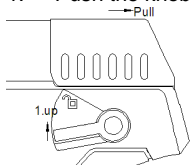

- Take the spring out from the glass tube ,then remove the solder waste

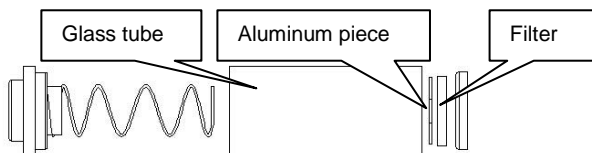

Put the spring back to glass tube, then put glass tube back to position.Press the back holder, then the knob will bullet down and become locked automatically .

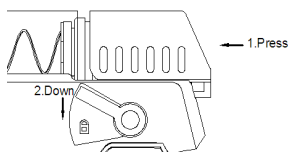

INSTRUCTIONS:

- After each operation is finished, please idling suck the desoldering gun 3-5 times soon, this can clean the solder waste inside the pipe.
- If the operation interval is about 20 minutes, after idling sucking the desoldering gun, please also use the cleaning tool to clean the pipe.
- When you find the desoldering efficiency gets down, please use the cleaning Pin to clean the pipe immediately.
- If the operation interval is long, we advise to adjust the temperature to about 200° C . When you use it again, you can adjust to the working temperature,
- When the glass tube has absorbed about 1/2 solder waste, please clean it immediately. When you find the filter is getting hardened, please replace the filter immediately.

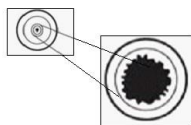

The Nozzle hole will get enlarged with corrosion.

CAUTION

The Nozzle hole will get enlarged with corrosion, but such phenomena can not be noticed easily. Therefore, if desoldering efficiency goes down and all other parts appear to be OK, the nozzle is probably eroded and should be replaced.

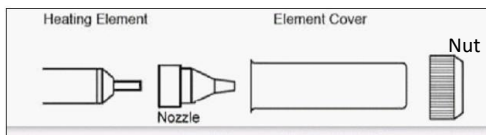

Troubleshooting

Fault phenomenon	Failure cause	solution
LCD No display	Fail to connect power source	Check the power cord connection and plug in the power cord to power Jack.
	Fuse blown	Replace fuse : 3.15A / 250V
Fail to Set temperature	Key damage	Return to dealer
Suction non-action	Trigger switch damage	Return to dealer
	Motor damage	Return to dealer
Nozzle is not hot	Heating element damaged	Return to dealer
	internal wire damage	Return to dealer
Can not melt solder	Unreasonable setting of temperature	Reset the appropriate temperature
	nozzle oxidation	Replace nozzle
	nozzle is not hot	Return to dealer
Suction ability is low	Blow- by	Check the connection of vacuum outlet Check the installation of glass tube
	Excessive solder waste storage in glass tube	Removing solder waste from glass tube
	Filter degradation	Replacement of filter
	Air pump bad	Return to dealer
Unable to absorb solder	solder hole blocked	under heating condition, using cleaning pin to clean heating element
	Solder melt inadequately	when solder is completely melted
Tin absorption hole blocked, can not be dredged	Solder waste accumulate at the end of heating element	Take off the glass tube, use the soldering iron to heat the steel pipe back to remove the solder waste, and then use the cleaning pin to dredge.

Checking the heating element:

Disconnect the plug and measure the resistance value between the desoldering gun connecting plug pins as follows.



a. Between pins 1 & 2 (Sensor)	50Ω±3Ω (25°C room temperature)
b. Between pins 3 & 4 (Heating Element)	2Ω±1Ω (25°C room temperature)
c. Between pin 5 & 6	0Ω (tigger on)
d. Between pin 7 & 2	open or 0Ω(shaking gun)

If the resistance values of 'a' and 'b' are outside the above value, replace the heating element (sensor).

If the resistance values of 'd' is outside the above value, Sleep mode was lose efficacy

Replace the heating element:

- 1) Disconnect the power plug, wait unit the desoldering gun temperature down to room temperature.
- 2) Loosen screws and disassemble desoldering gun.
- 3) Cut off the wire of heating element, prepare a new heating element (model no. 5SS-331N1-H).as follow figure.



- 4) Connect heating element :

Put the heating element on the black heating element holder, insert the heat shrink tube (Φ3x25mm) and metal tube (Φ2x6mm) to the wire, connect wire and pull the metal tube to the connect position, crimping the metal tube with crimper tool, pull the heat shrink tub to the metal tube and heating.

- Long blue wire (ground) connects to the yellow wire in handle
- Two white wires (heating element) connect to the two red wire, no need to distinguish positive electrode and negative electrode.



- Two blue wires (Sensor) connect to the black and blue wire in handle, no need to distinguish positive electrode and negative electrode.
 - Any one wire connect to the Sleep control sensor
- 5) Measure the resistance value again, make sure the value is correct. Short the desoldering gun nozzle and shell of plug, and the resistance value should be 0Ω.
 - 6) Assembly desoldering gun again, do not press the wire or put into the wrong position.

Note : The color of wire for reference, color change without notice.

Any repair or replacement operation by professional operator